

REINIGUNGS- UND DESINFEKTIONSANLEITUNG DÜRR SAUGHANDSTÜCK CLEANING- AND DISINFECTING INSTRUCTIONS DÜRR SUCTION HANDPIECE

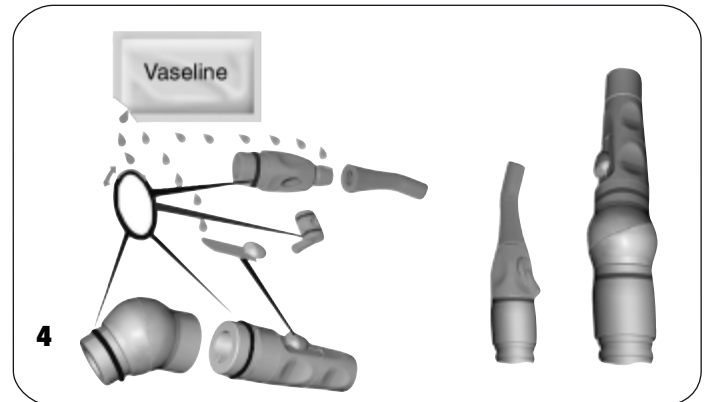

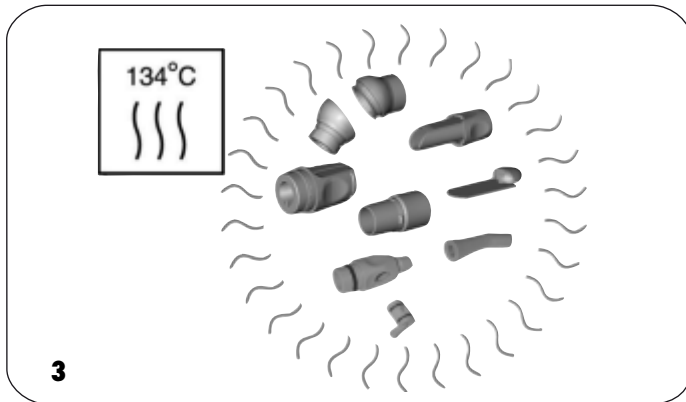
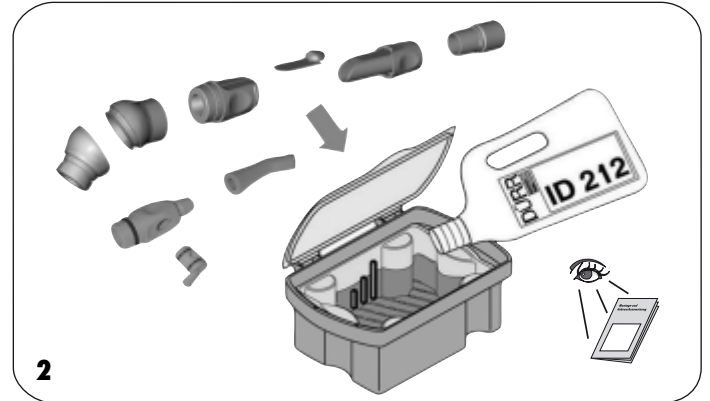
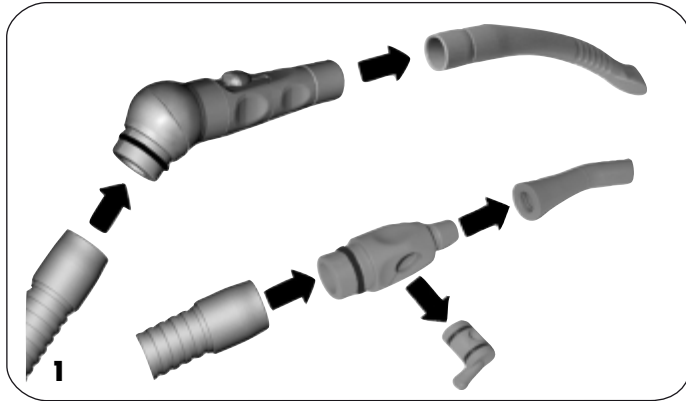

Beispiel / Example

7600A010-22 A = grau / grey

7600S010-22 S = schwarz / black

O-Ring Set 7600-008-00

1x O-Ring 14 x 2
2x O-Ring 18 x 2
1x O-Ring 22 x 2

*** O-Ringe nur im Set erhältlich !
O-rings only available in kit !**

7600A010-20



7600A010-22
7600S010-22



7600A010-16



7600A010-18
7600S010-18

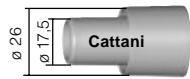

7600A010-19



7600A030-00
7600S030-00



O-Ring 22 x 2*
O-Ring 18 x 2*

7600A010-00 (1 Stck./piece)
7600S010-00 (1 Stck./piece)

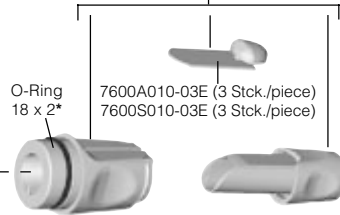

O-Ring
18 x 2*

7600A040-00 (1 Stck./piece)
7600S040-00 (1 Stck./piece)

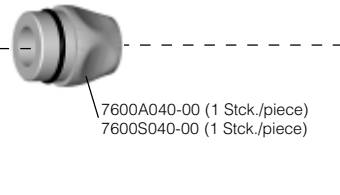

7600A010-08
7600S010-08

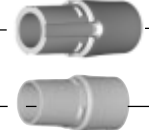

7600A010-04
7600S010-04

7600A010-07
7600S010-07

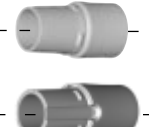

7600A010-30
7600S010-30

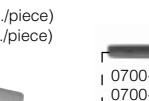

7600A020-00 (1 Stck./piece)
7600S020-00 (1 Stck./piece)

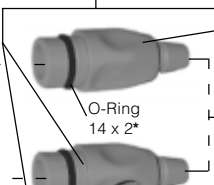

O-Ring
14 x 2*

7600A021-00 (1 Stck./piece)
7600S021-00 (1 Stck./piece)

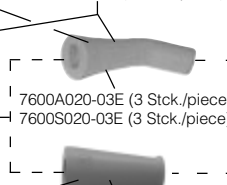

7600A020-03E (3 Stck./piece)
7600S020-03E (3 Stck./piece)



7600A020-05E (3 Stck./piece)
7600A020-55 (1 Stck./piece)



7600A020-02 (1 Stck./piece)
7600S020-02 (1 Stck./piece)



7068A003-05
7068S003-05

0700-054-00 (20 Stck./piece)

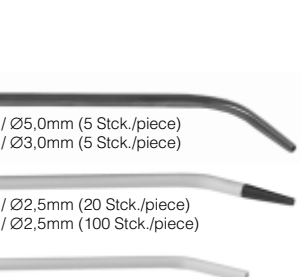
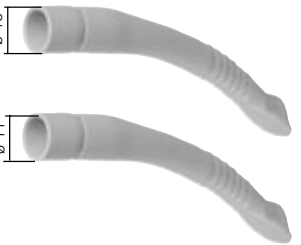

0700-005-00 / Ø5,0mm (5 Stck./piece)
0700-007-00 / Ø3,0mm (5 Stck./piece)

0700-005-50 / Ø2,5mm (20 Stck./piece)
0700-005-51 / Ø2,5mm (100 Stck./piece)

0700-007-50 / Ø4,8mm (20 Stck./piece)
0700-007-51 / Ø4,8mm (100 Stck./piece)

DÜRR DENTAL AG

Höpfigheimer Strasse 17 · 74321 Bietigheim-Bissingen/Germany
Tel: +49 7142705-0 · Fax: +49 7142705-500
info@duerr.de · www.duerr.de

9000-606-16/ 01



2009/02

